

PEGATRON

CADCAM

Or Capture Viewer

安裝說明

V001

Revision	Description	Date	Authorities
V001	Initial Release	11/28/2008	Jeremy Yan

OrCAD Viewer Demo 為提供查看線路圖的 Free 軟體，其安裝步驟如下：

1. 軟體安裝軟體目錄為 [\\ptw-cis-01\Tools\Viewer\OrCAD_Viewer](K:\Tools\Viewer\OrCAD_Viewer)
2. 執行 CaptureViewer51p.exe 進行安裝。

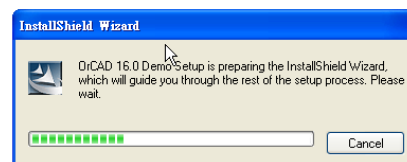
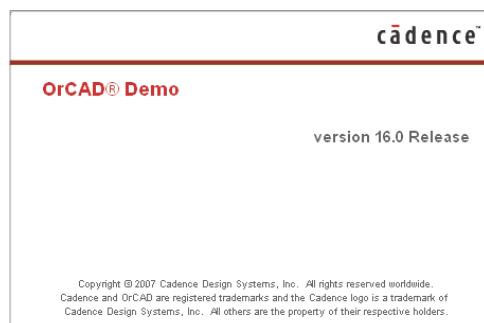
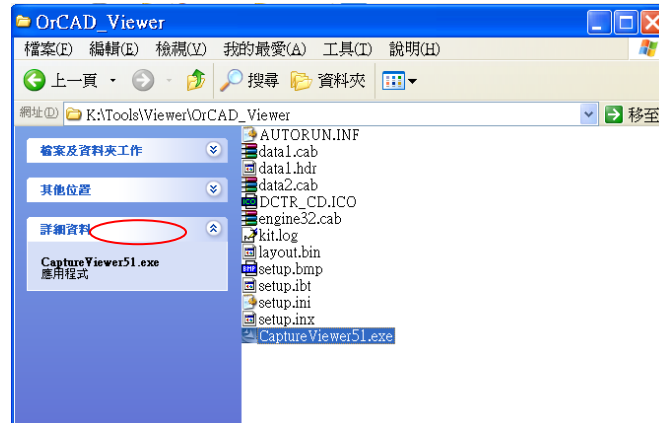

3. I accept the terms of the license agreement

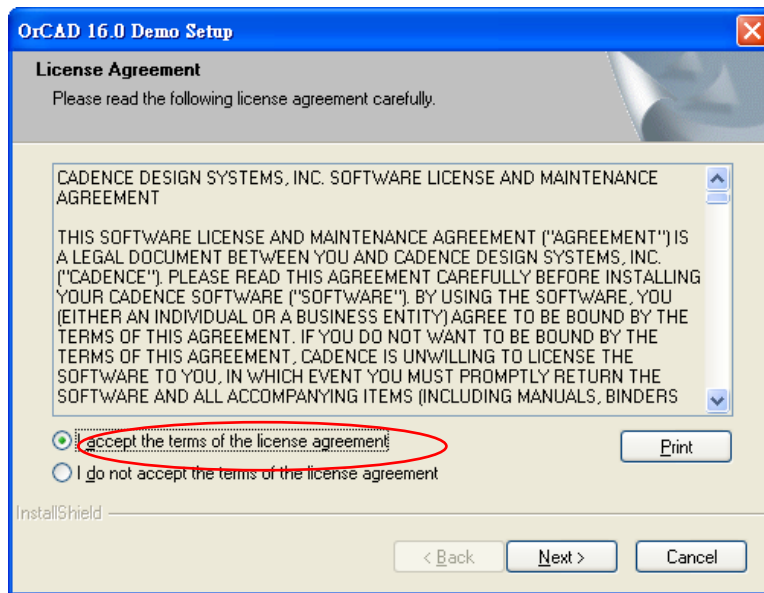

4. 建議安裝時關閉掃毒程式，點擊<確定>繼續安裝。

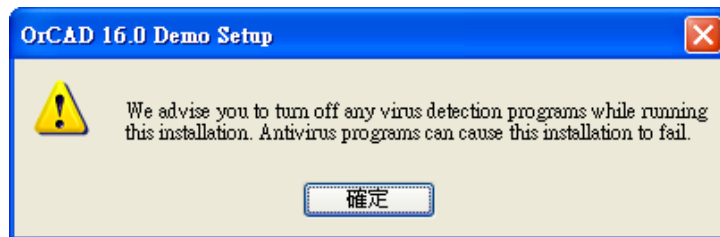

5. 選擇安裝目錄，預設目錄為 C:\OrCad\OrCad_16.0_Demo，建議使用該預設目錄。

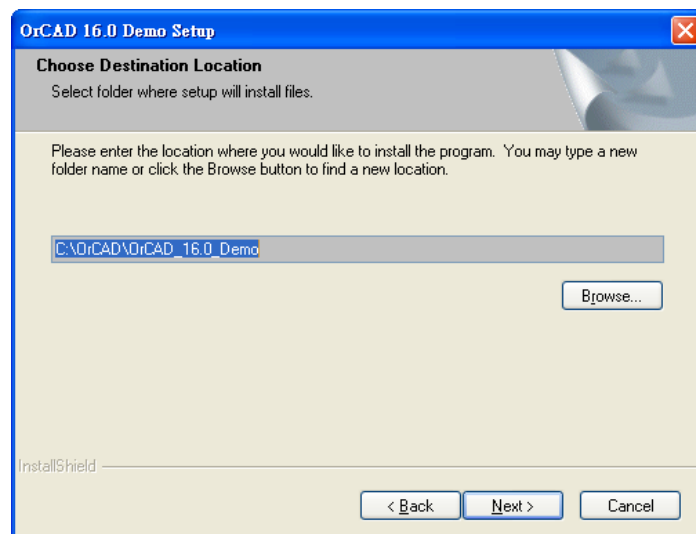

6. 點擊 <Next> 繼續安裝。

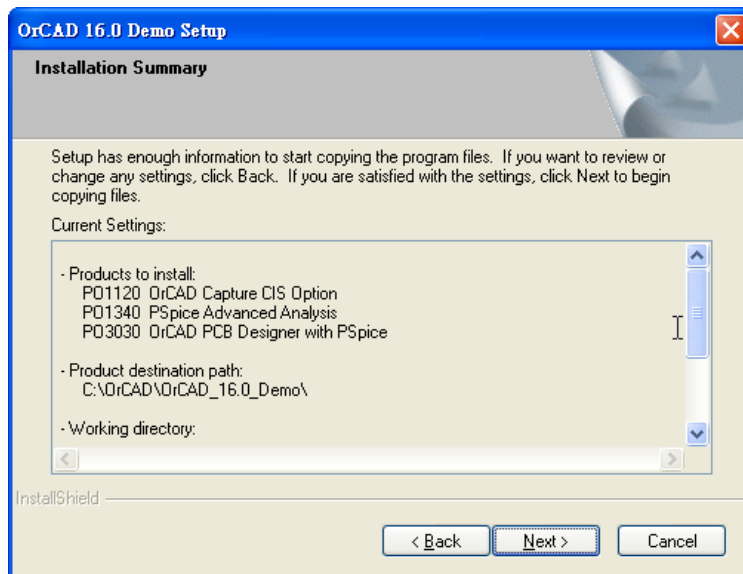
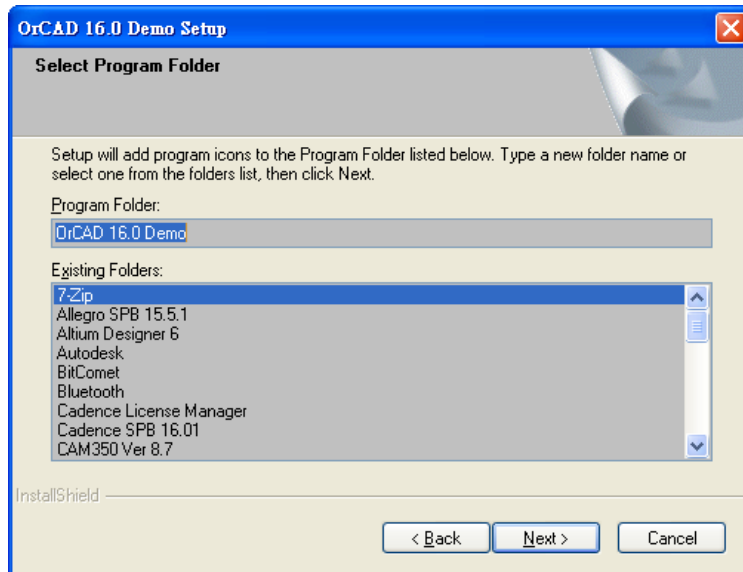

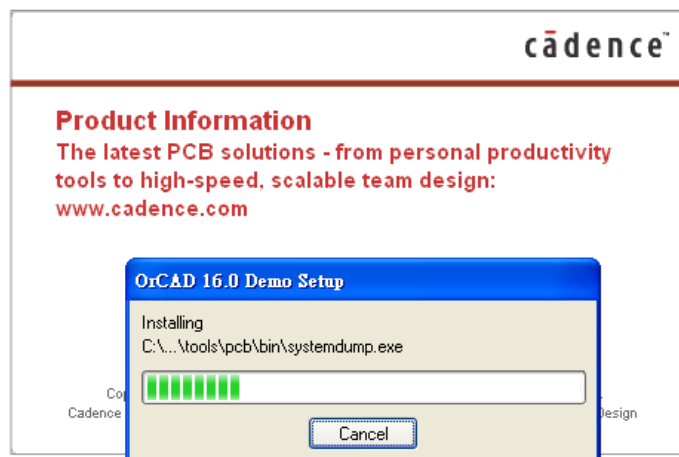

7. 點選<是(Y)>，或<否(N)>均可

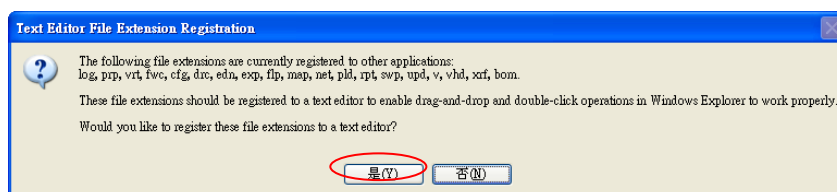
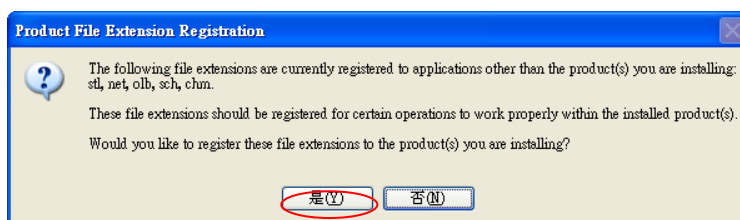

8. 安裝完畢後點擊 Finish 即可

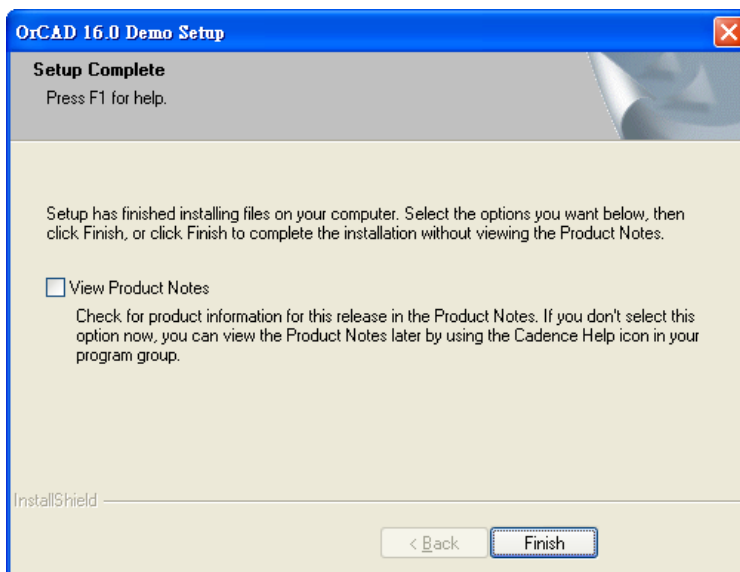

9.

執行 OrCAD Capture CIS Demo 程式，正常開啓即安裝完成，可正常使用。

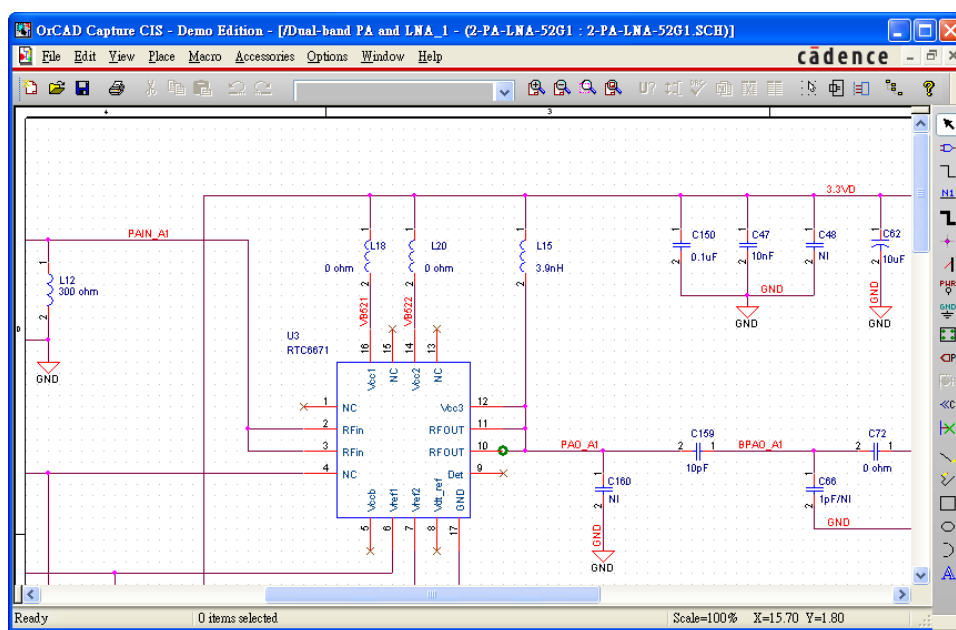
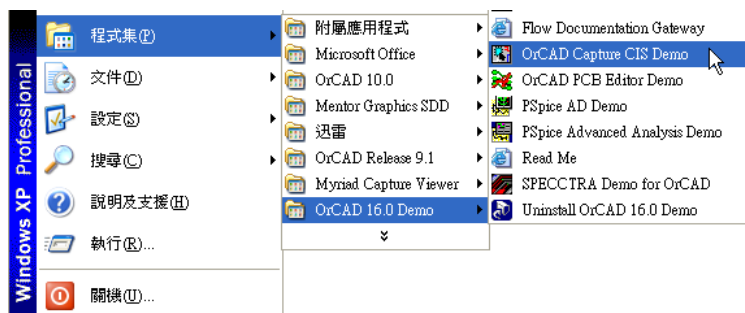

注: Demo 版開啓時會出現只能編輯零件不多於 60 個，以及 Net 不多於 64 條的線路圖將不能儲存的提示。點擊<確定>後便正常查看線路圖。

